

Exploded diagram and spare parts list









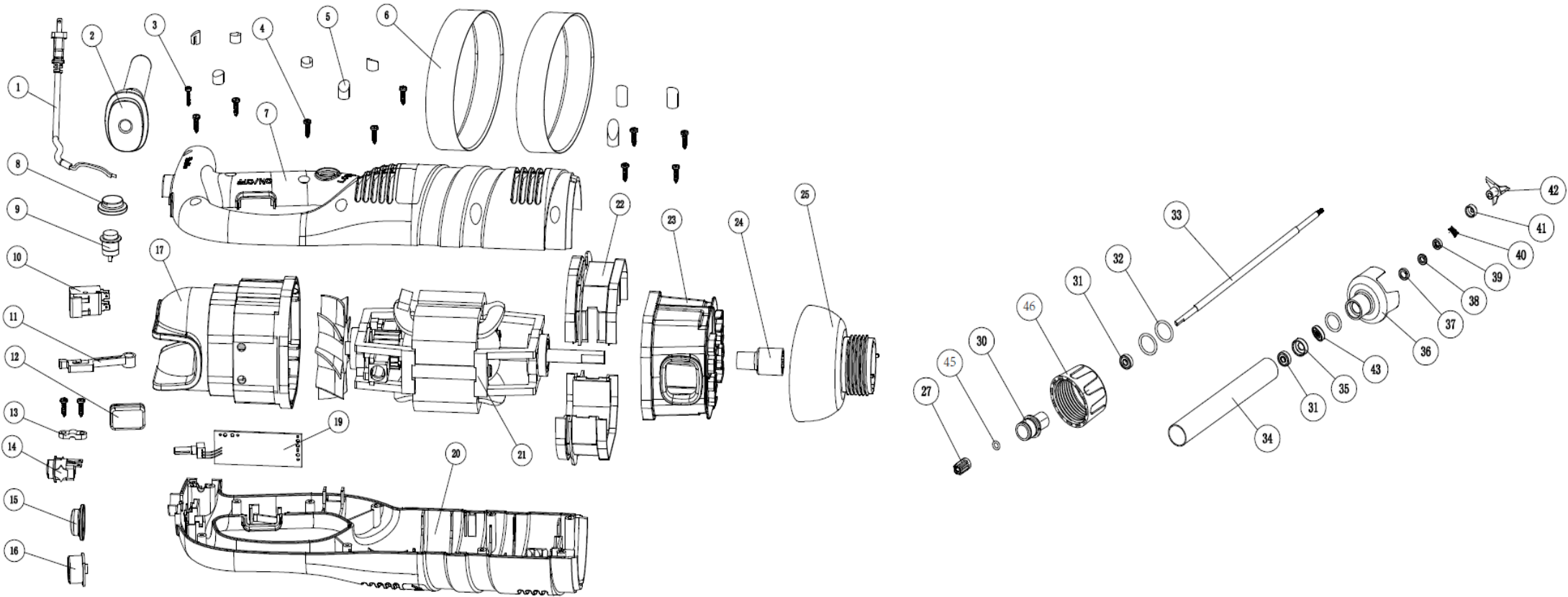



















For machines with – FS442-A-02

[Click](#)

For machines with – FS442-A









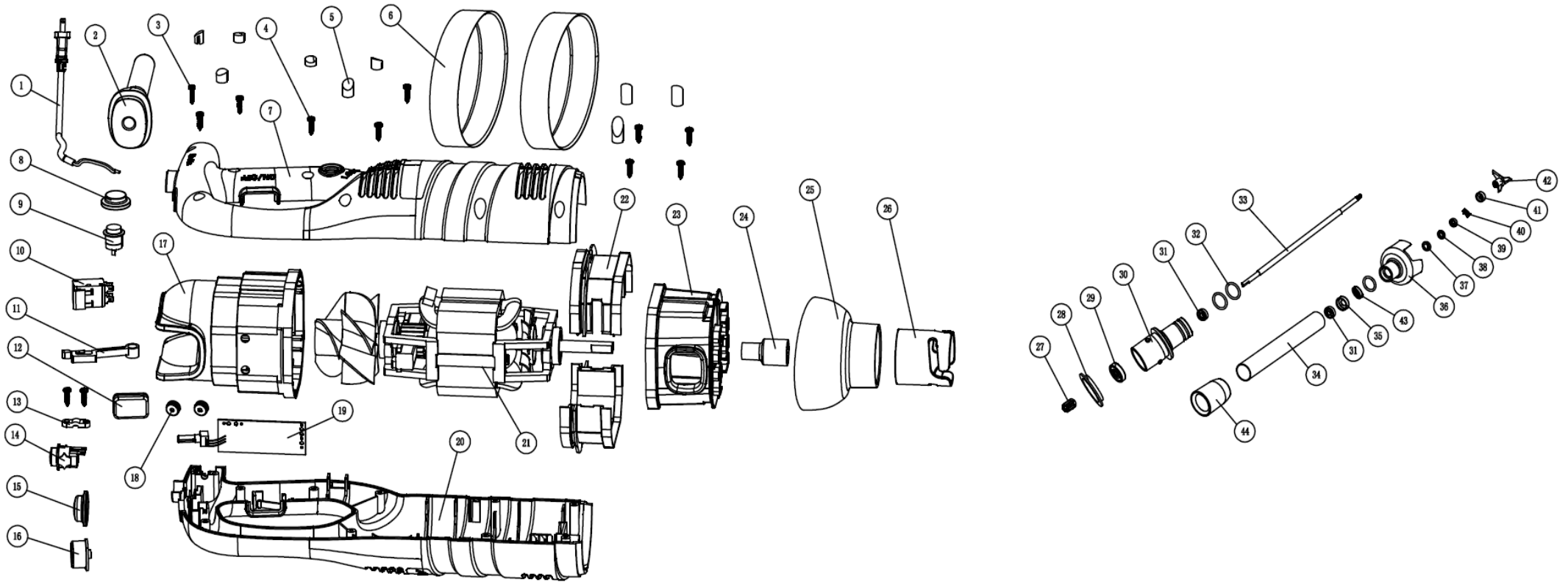

















[Click](#)



Machine	Explode	Code	Description
FS442-A Apuro Stick Blender - 500mm Shaft	1		Power Cord
FS442-A Apuro Stick Blender - 500mm Shaft	2	AL134	Strain Relief
FS442-A Apuro Stick Blender - 500mm Shaft	3		Screw
FS442-A Apuro Stick Blender - 500mm Shaft	4		Screw
FS442-A Apuro Stick Blender - 500mm Shaft	5	AL239	Screw Plunger Set
FS442-A Apuro Stick Blender - 500mm Shaft	6		Silicone Decoration Ring
FS442-A Apuro Stick Blender - 500mm Shaft	7	AL135	Upper Housing
FS442-A Apuro Stick Blender - 500mm Shaft	20		Lower Housing
FS442-A Apuro Stick Blender - 500mm Shaft	8	AL136	Waterproof Cap 2
FS442-A Apuro Stick Blender - 500mm Shaft	9		Lock Button
FS442-A Apuro Stick Blender - 500mm Shaft	10	AL137	On-Off Switch
FS442-A Apuro Stick Blender - 500mm Shaft	11		Switch Osculant Shaft
FS442-A Apuro Stick Blender - 500mm Shaft	12		Rubber Interlocking Protector
FS442-A Apuro Stick Blender - 500mm Shaft	13		Pressing Board
FS442-A Apuro Stick Blender - 500mm Shaft	14	AL138	Safety Button
FS442-A Apuro Stick Blender - 500mm Shaft	15		Waterproof Cap 1
FS442-A Apuro Stick Blender - 500mm Shaft	16	AL139	Variable Speed Knob
FS442-A Apuro Stick Blender - 500mm Shaft	17		Air Outlet Spacer
FS442-A Apuro Stick Blender - 500mm Shaft	19	AL140	PCB
FS442-A Apuro Stick Blender - 500mm Shaft	21	AL141	Motor
FS442-A Apuro Stick Blender - 500mm Shaft	22		Motor Spacer
FS442-A Apuro Stick Blender - 500mm Shaft	23		Air Inlet Spacer
FS442-A Apuro Stick Blender - 500mm Shaft	24		Spline Sleeve
FS442-A Apuro Stick Blender - 500mm Shaft	25	AN825	Aluminium Head with Screw
FS442-A Apuro Stick Blender - 500mm Shaft	27	AN663	Spline
FS442-A Apuro Stick Blender - 500mm Shaft	28		Rubber Mat
FS442-A Apuro Stick Blender - 500mm Shaft	29		Oil Seal
FS442-A Apuro Stick Blender - 500mm Shaft	30		Connect Sleeve
FS442-A Apuro Stick Blender - 500mm Shaft	31		Bearing
FS442-A Apuro Stick Blender - 500mm Shaft	32		Connect Sleeve Seal Ring
FS442-A Apuro Stick Blender - 500mm Shaft	33		Output Axis
FS442-A Apuro Stick Blender - 500mm Shaft	34		304 S/S Tube
FS442-A Apuro Stick Blender - 500mm Shaft	35		Bearing Sleeve
FS442-A Apuro Stick Blender - 500mm Shaft	36		Knife Protector
FS442-A Apuro Stick Blender - 500mm Shaft	37		Ceramic Ring Sleeve
FS442-A Apuro Stick Blender - 500mm Shaft	38		Ceramic Ring
FS442-A Apuro Stick Blender - 500mm Shaft	39		Graphite Ring
FS442-A Apuro Stick Blender - 500mm Shaft	40		Graphite Ring Spring
FS442-A Apuro Stick Blender - 500mm Shaft	41		Convex Ring
FS442-A Apuro Stick Blender - 500mm Shaft	42	AL143	Smooth Blade
FS442-A Apuro Stick Blender - 500mm Shaft	43		Oil Seal
FS442-A Apuro Stick Blender - 500mm Shaft	45		Spline Sleeve
FS442-A Apuro Stick Blender - 500mm Shaft	46		Thread Lock

Machine	Explode	Code	Description
FS442-A Apuro Stick Blender - 500mm Shaft	27-46	AN828	Complete Blender Head/Shafts
FS442-A Apuro Stick Blender - 500mm Shaft	N/A	AL205	Wall Hanger
FS442-A Apuro Stick Blender - 500mm Shaft	N/A	AN834	Whisk
FS442-A Apuro Stick Blender - 500mm Shaft	N/A	AL238	Blade Removal Kit



Machine	Explode	Code	Description
FS442-A Apuro Stick Blender - 500mm Shaft	1		Power Cord
FS442-A Apuro Stick Blender - 500mm Shaft	2	AL134	Strain Relief
FS442-A Apuro Stick Blender - 500mm Shaft	3		Screw
FS442-A Apuro Stick Blender - 500mm Shaft	4		Screw
FS442-A Apuro Stick Blender - 500mm Shaft	5	AL239	Screw Plunger Set
FS442-A Apuro Stick Blender - 500mm Shaft	6		Silicone Decoration Ring
FS442-A Apuro Stick Blender - 500mm Shaft	7	AL135	Upper Housing
FS442-A Apuro Stick Blender - 500mm Shaft	20		Lower Housing
FS442-A Apuro Stick Blender - 500mm Shaft	8	AL136	Waterproof Cap 2
FS442-A Apuro Stick Blender - 500mm Shaft	9		Lock Button
FS442-A Apuro Stick Blender - 500mm Shaft	10	AL137	On-Off Switch
FS442-A Apuro Stick Blender - 500mm Shaft	11		Switch Osculant Shaft
FS442-A Apuro Stick Blender - 500mm Shaft	12		Rubber Interlocking Protector
FS442-A Apuro Stick Blender - 500mm Shaft	13		Pressing Board
FS442-A Apuro Stick Blender - 500mm Shaft	14	AL138	Safety Button
FS442-A Apuro Stick Blender - 500mm Shaft	15		Waterproof Cap 1
FS442-A Apuro Stick Blender - 500mm Shaft	16	AL139	Variable Speed Knob
FS442-A Apuro Stick Blender - 500mm Shaft	17		Air Outlet Spacer
FS442-A Apuro Stick Blender - 500mm Shaft	18		Wire Guard Ring
FS442-A Apuro Stick Blender - 500mm Shaft	19	AL140	PCB
FS442-A Apuro Stick Blender - 500mm Shaft	21	AL141	Motor
FS442-A Apuro Stick Blender - 500mm Shaft	22		Motor Spacer
FS442-A Apuro Stick Blender - 500mm Shaft	23		Air Inlet Spacer
FS442-A Apuro Stick Blender - 500mm Shaft	24	AL142	Spline Sleeve
FS442-A Apuro Stick Blender - 500mm Shaft	25	AN825+AN828	Aluminium Head with Screw
FS442-A Apuro Stick Blender - 500mm Shaft	26		Locking Sleeve
FS442-A Apuro Stick Blender - 500mm Shaft	27	AN663	Spline
FS442-A Apuro Stick Blender - 500mm Shaft	28		Rubber Mat
FS442-A Apuro Stick Blender - 500mm Shaft	29		Oil Seal
FS442-A Apuro Stick Blender - 500mm Shaft	30		Connect Sleeve
FS442-A Apuro Stick Blender - 500mm Shaft	31		Bearing
FS442-A Apuro Stick Blender - 500mm Shaft	32		Connect Sleeve Seal Ring
FS442-A Apuro Stick Blender - 500mm Shaft	33		Output Axis
FS442-A Apuro Stick Blender - 500mm Shaft	34		304 S/S Tube
FS442-A Apuro Stick Blender - 500mm Shaft	35		Bearing Sleeve
FS442-A Apuro Stick Blender - 500mm Shaft	36		Knife Protector
FS442-A Apuro Stick Blender - 500mm Shaft	37		Ceramic Ring Sleeve
FS442-A Apuro Stick Blender - 500mm Shaft	38		Ceramic Ring
FS442-A Apuro Stick Blender - 500mm Shaft	39		Graphite Ring
FS442-A Apuro Stick Blender - 500mm Shaft	40		Graphite Ring Spring
FS442-A Apuro Stick Blender - 500mm Shaft	41		Convex Ring
FS442-A Apuro Stick Blender - 500mm Shaft	42	AL143	Smooth Blade
FS442-A Apuro Stick Blender - 500mm Shaft	43		Oil Seal

Machine	Explode	Code	Description
FS442-A Apuro Stick Blender - 500mm Shaft	44		Silicone Sleeve
FS442-A Apuro Stick Blender - 500mm Shaft	27-44	AN825+AN828	Complete Blender Head/Shafts
FS442-A Apuro Stick Blender - 500mm Shaft	N/A	AL205	Wall Hanger
FS442-A Apuro Stick Blender - 500mm Shaft	N/A	AL228	Whisk
FS442-A Apuro Stick Blender - 500mm Shaft	N/A	AL238	Blade Removal Kit